

BORAS 2D3S

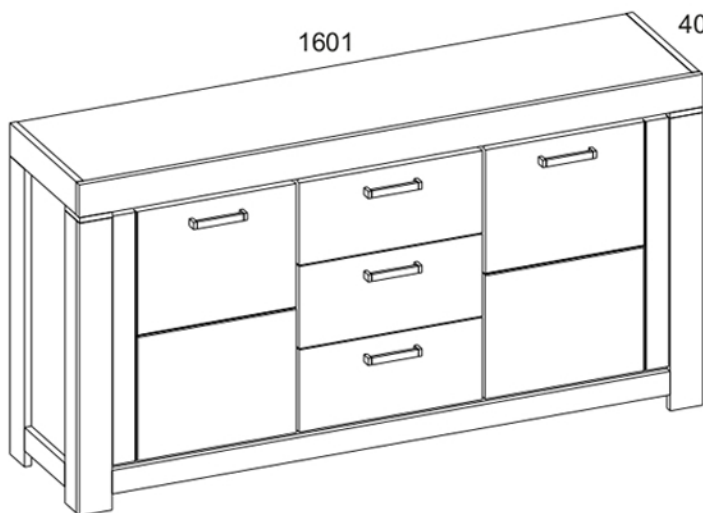

1601

400





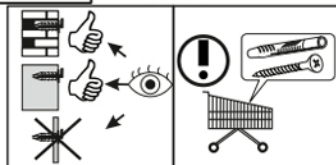
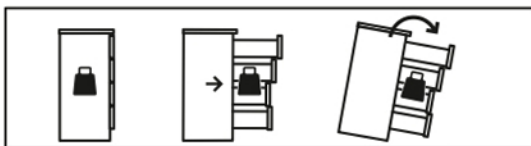
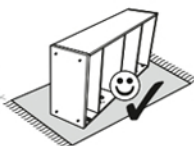
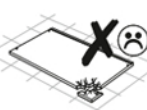
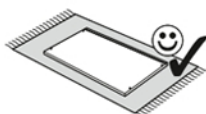
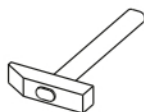
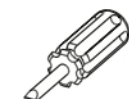

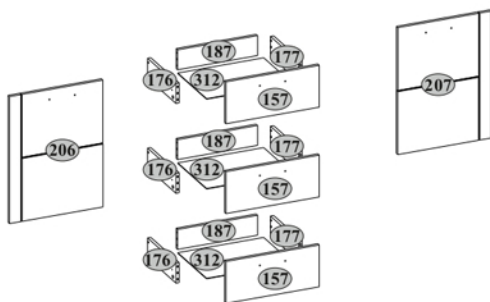
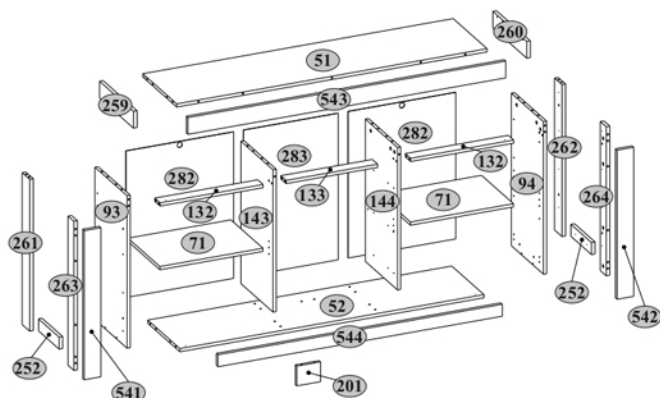



849

























№	L, mm	B, mm	H, mm	Q	№ pack
51	1563	382	16	1	2/2
52	1531	362	16	1	2/2
71	519	360	16	2	1/2
93	764	362	16	1	2/2
94	764	362	16	1	2/2
132	519	60	16	2	1/2
133	461	60	16	1	1/2
143	713	362	16	1	2/2
144	713	362	16	1	2/2
157	470	210	16	3	1/2
176	320	100	16	3	1/2
177	320	100	16	3	1/2
187	403	100	16	3	1/2
201	120	99	16	1	1/2
206	636	470	16	1	1/2
207	636	470	16	1	1/2
252	232	60	18	2	2/2
259	382	84	18	1	2/2
260	382	84	18	1	2/2
261	761	84	18	1	2/2
262	761	84	18	1	2/2
263	747	66	18	1	2/2
264	747	66	18	1	2/2
541	747	84	18	1	2/2
542	747	84	18	1	2/2
543	1601	84	18	1	2/2
544	1432	60	18	1	2/2
312	433	325	2,5	3	2/2
282	734	542	2,5	2	1/2
283	734	477	2,5	1	1/2

A2 	V14 
Ø15x13 43	84x84x14 2
C6 	Z10 
8x24 8	300 3

I 	1	mm
R23 	8	140
R53 	20	130
S3 	6	120
		110
		100
		90
		80
		70
		60
		50
		40
		30
		20
		10
		0

U5 	U21 
36x36 2	26x26x20 7
B5 	C1 
10x50 2	8x35 46

A1 	C7 	E16 
7x34 43	8x60 4	4
C2 	N1 	P5 
8x50 4	7	8
H61 	R24 	R27 
5	7x50 18	5,0x13 30
R3 	R102 	R105 
3x20 42	3,5x16 34	3,5x30 8
R32 	S5 	U 
4x27 10	Ø18 16	130x35x15 2
S1 	6	

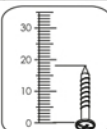

1**C1**

8x35

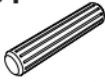

12

C7

8x60

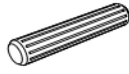

4

N1

1

P5

4

R27

5,0x13

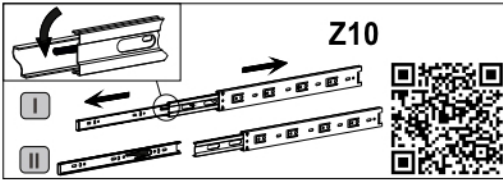

18

**Z10**

300

3

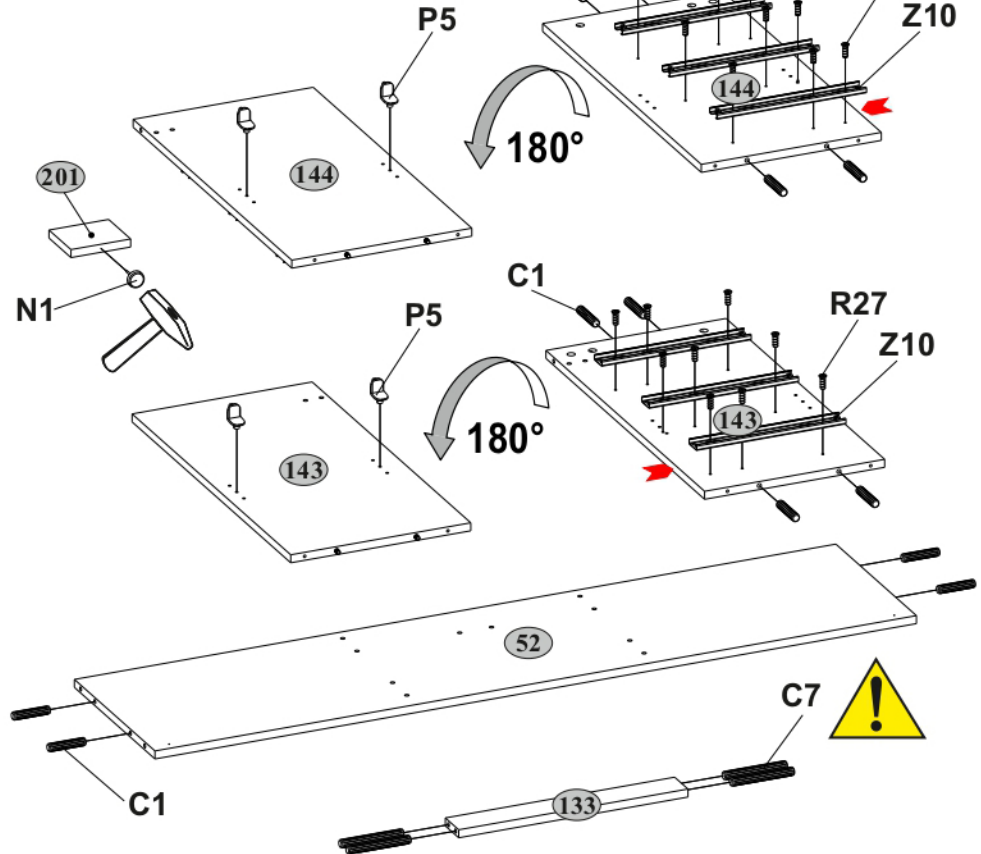
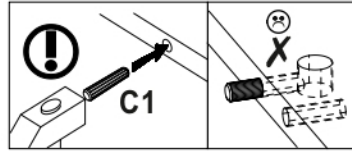
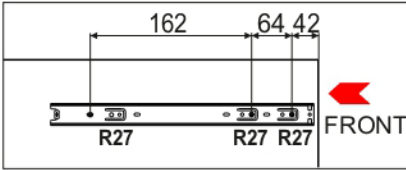

2

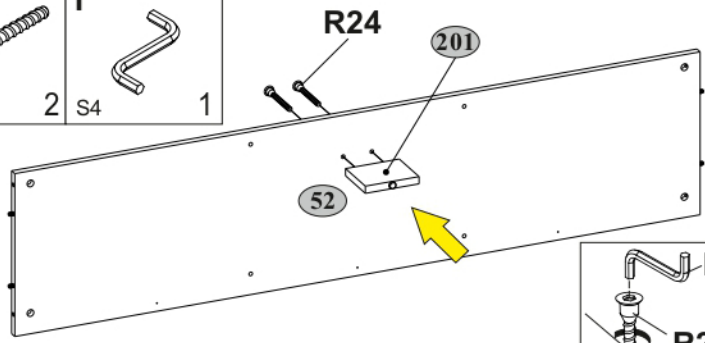
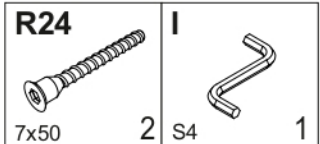

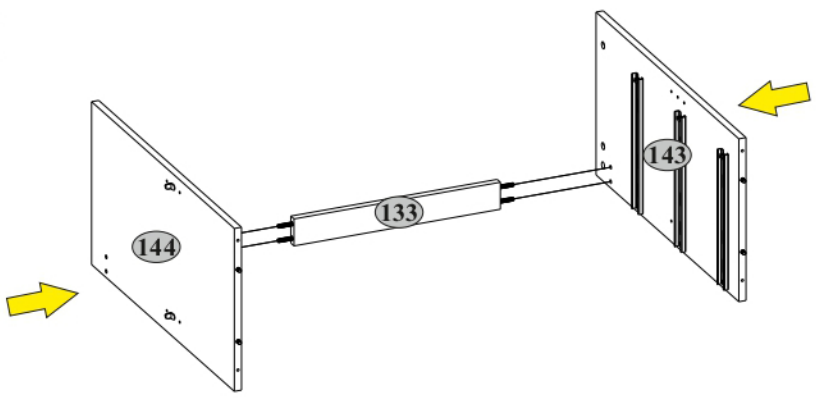

3

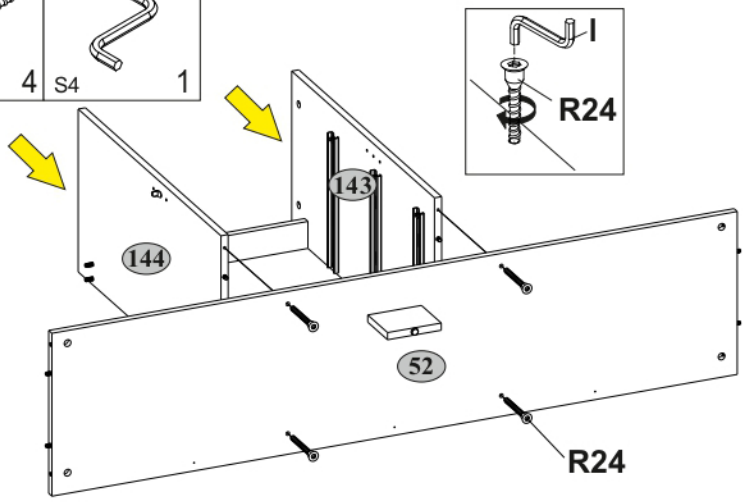
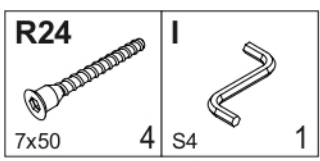

4



5

A1  7x34	C1  4 8x35	P5  10 4
--	--	--

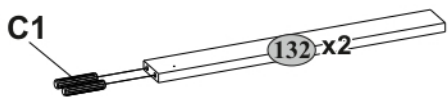
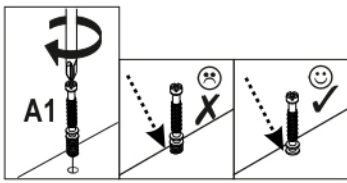
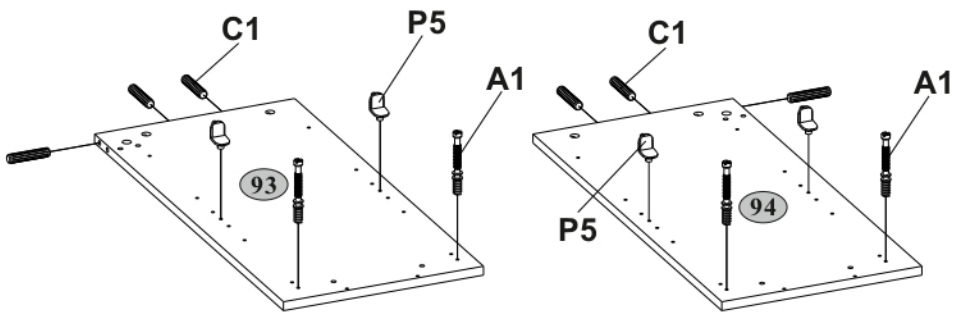
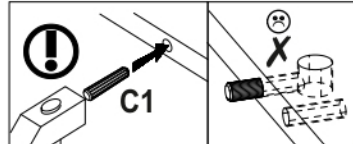

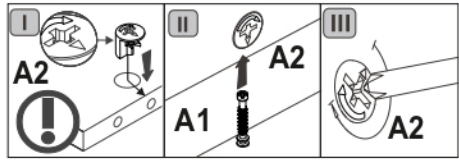
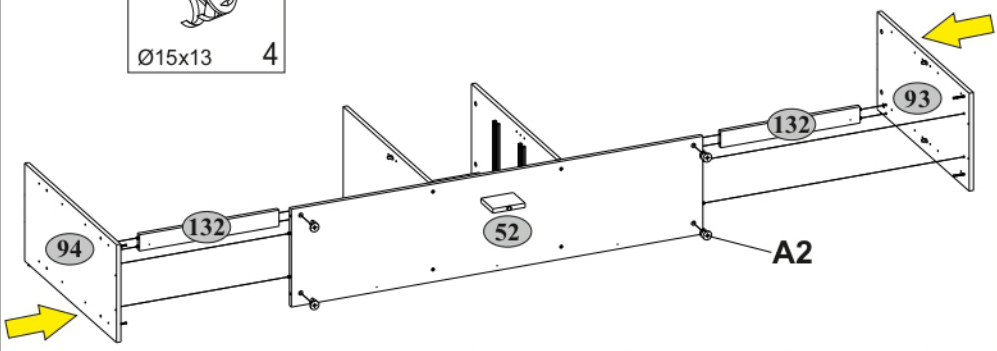

6

A2  Ø15x13	4
---	---



7

A1  7x34	C1  8 8x35	C6  6 8x24
--	--	--

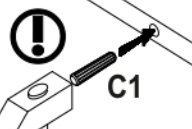
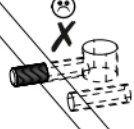
 C1	
---	--

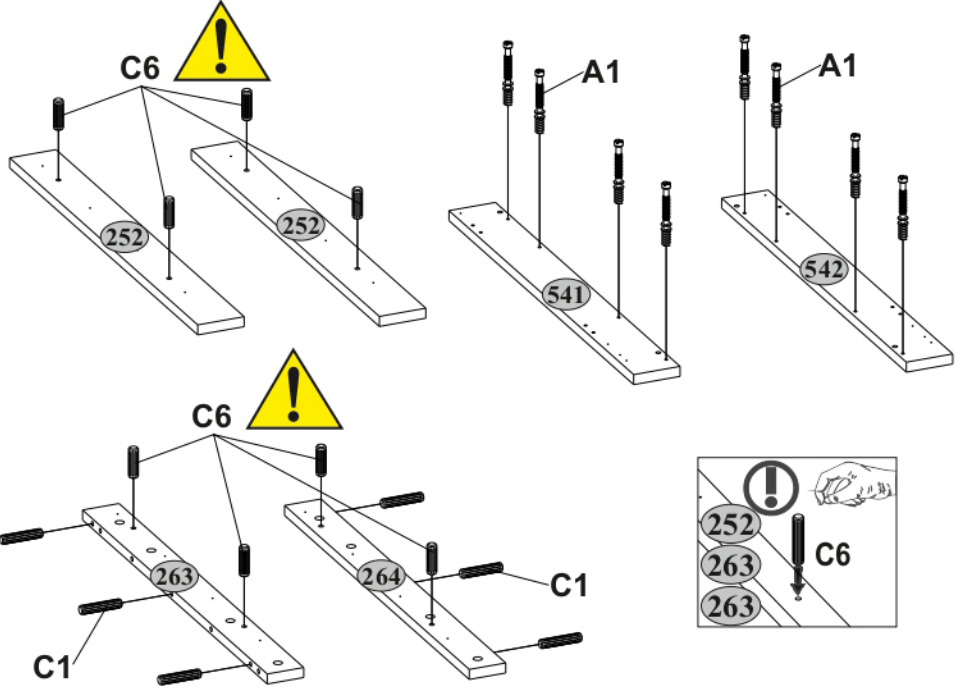

Assembly diagrams for step 7 showing the installation of screws C6 and A1 into panels 252, 541, 542, 263, and 264. Includes warning symbols.

8

A2  Ø15x13	8
--	---

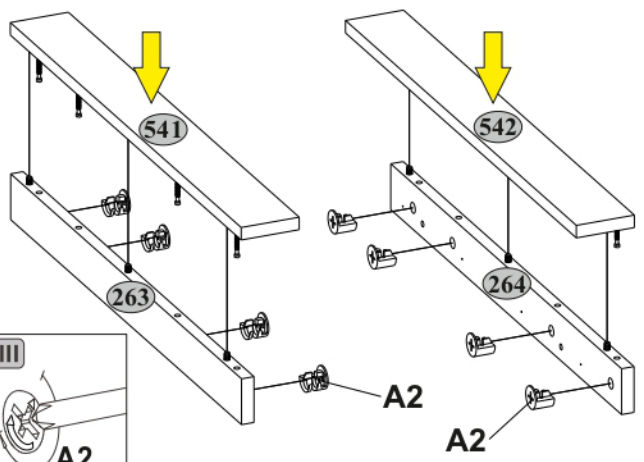

Assembly diagrams for step 8 showing the installation of washers A2 into panels 541, 542, and 264. Includes a yellow arrow indicating the direction of force.

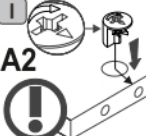
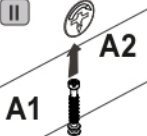
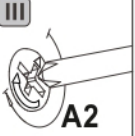
I  A2	II  A1 A2	III  A2
--	---	---

9**R105**

3,5x30

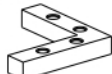
V14

8 84x84x14 2

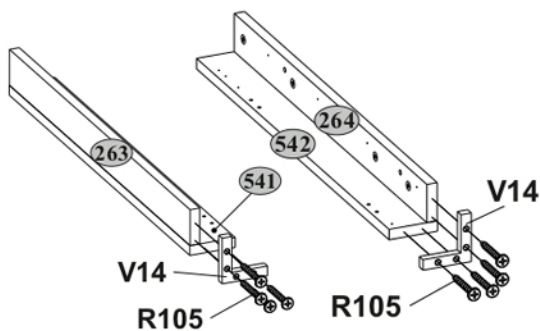
**10****R53**

4,2x32 8

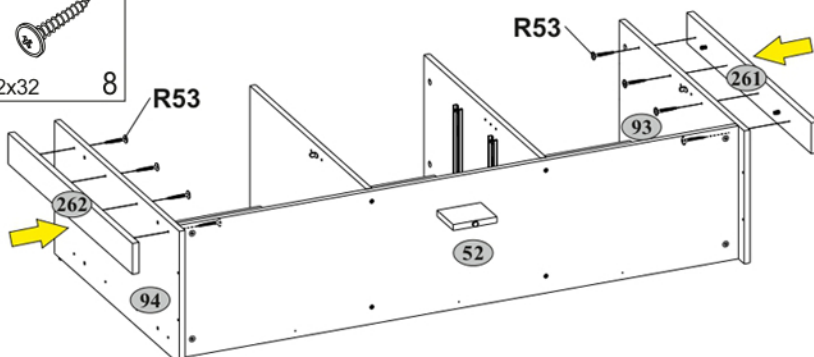
**11****R53**

4,2x32 12

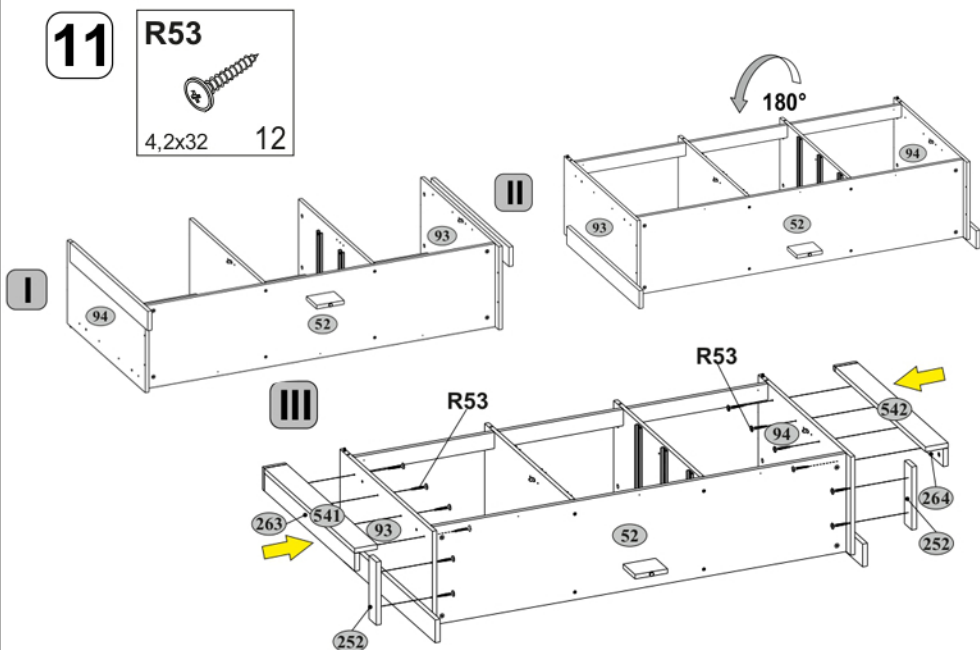

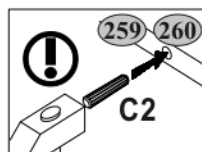
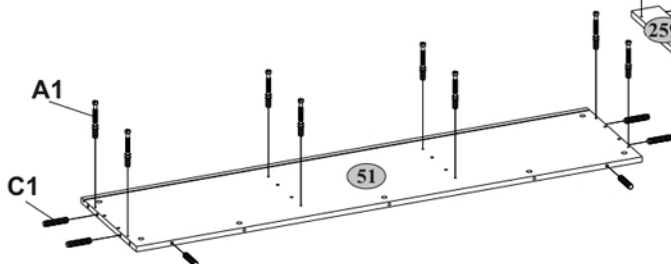
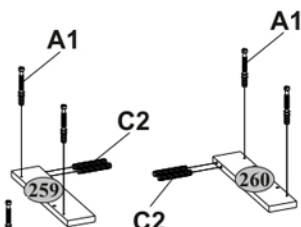
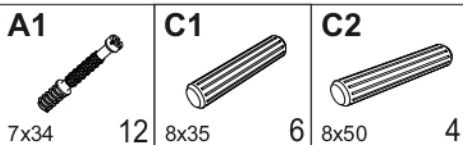
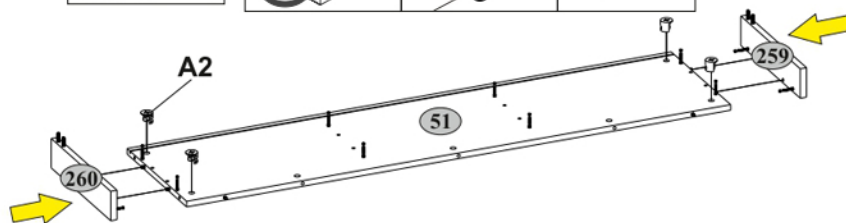
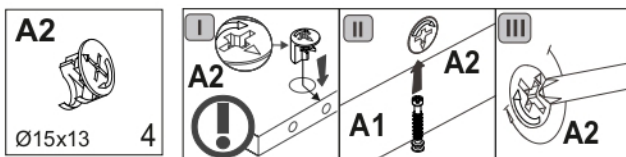
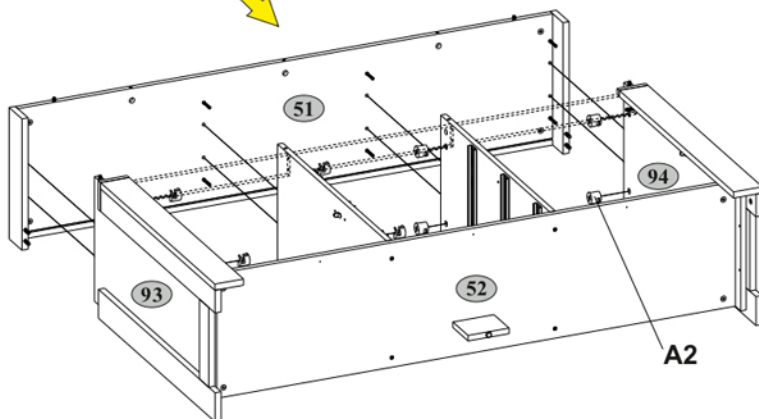
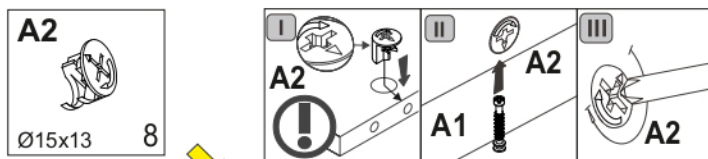
12**13****14**

15**A1**

7x34

7

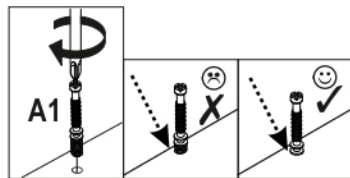
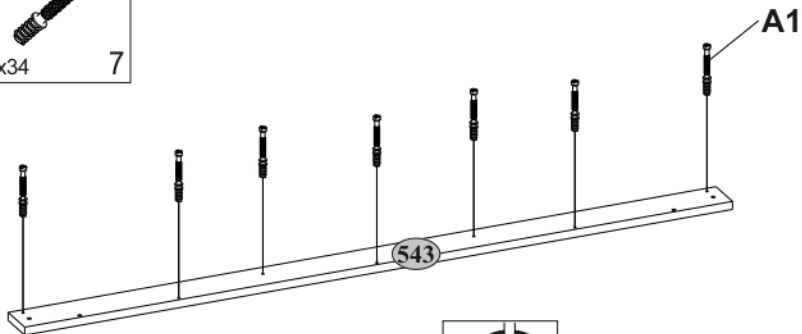
**16****A2**

Ø15x13

7

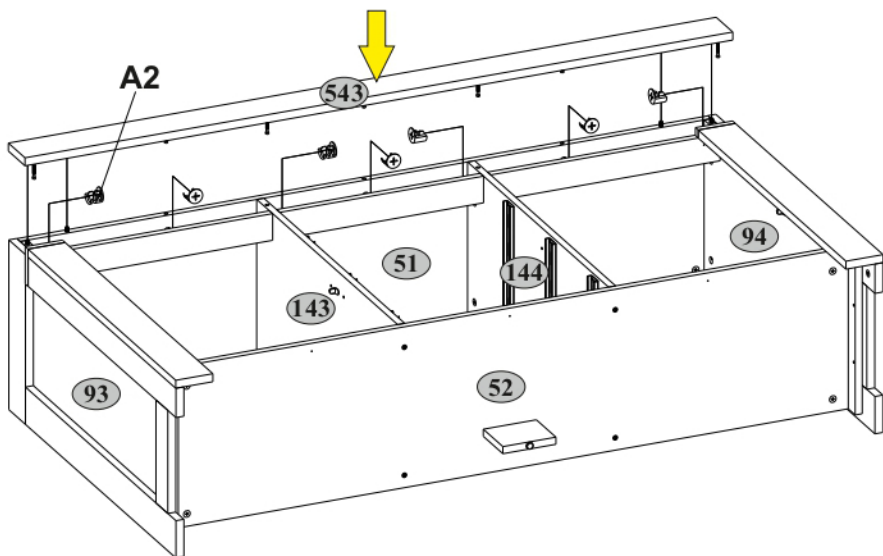
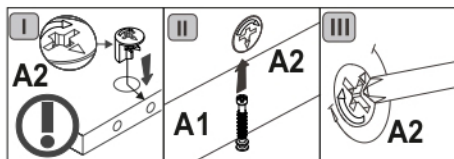

17**R102**

3,5x16

22

U5

36x36

U21

26x26x20

7

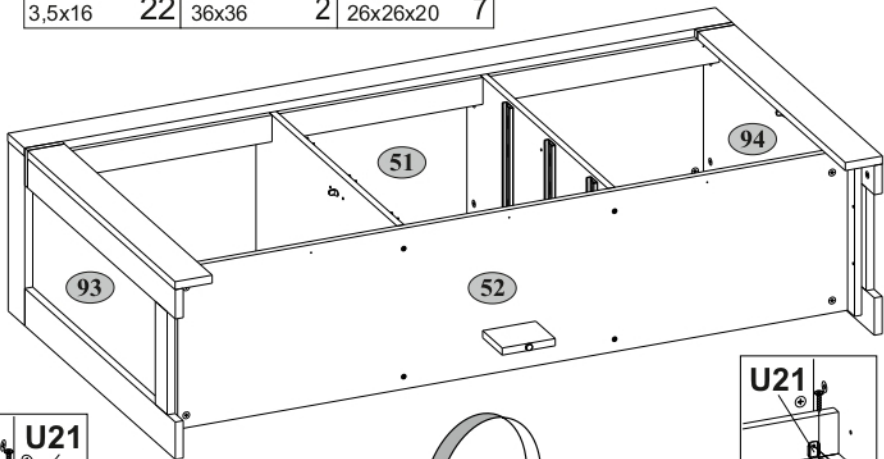
I

180°

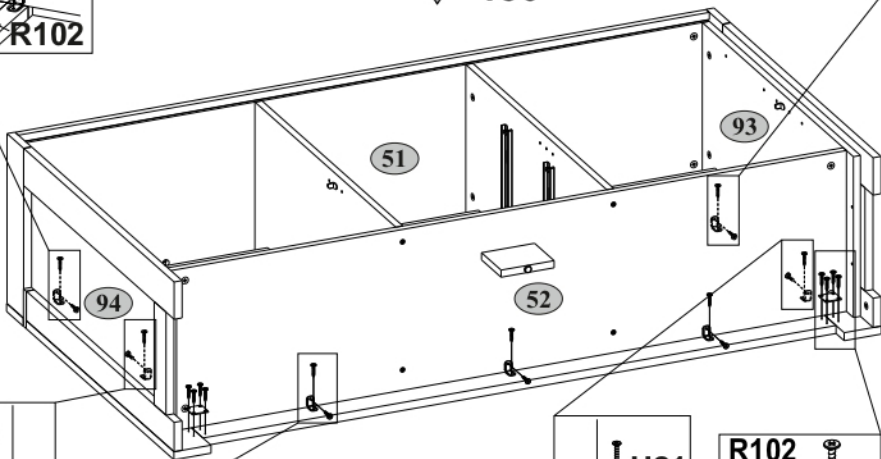
II**U21****R102****U21****R102****R102****U5****1****U21****2****R102****U21****3****U21****4****U21**



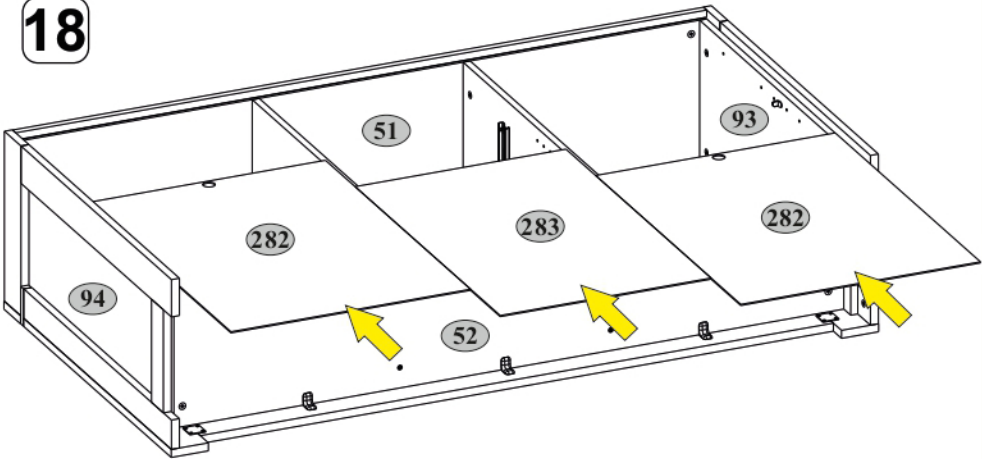



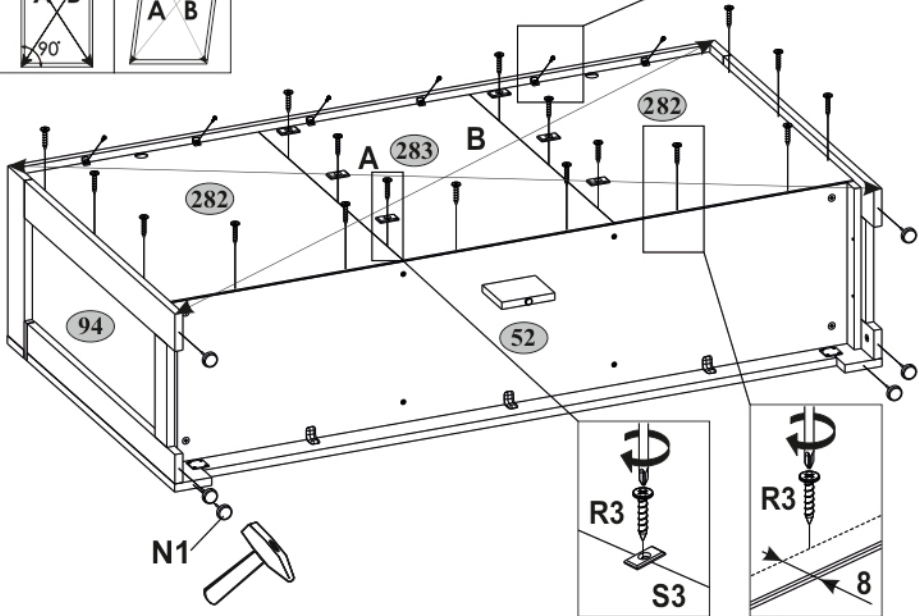
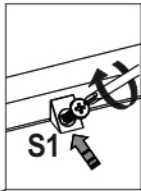
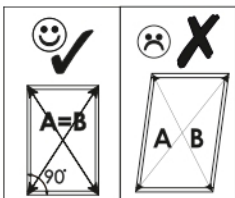
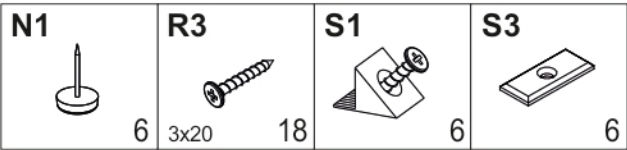



18

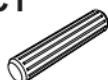

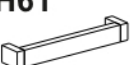
19



20x3

A1  7x34 12	A2  Ø15x13 12	C1  8x35 12	I  S4 1	H61  3
R24  7x50 12	R27  5,0x13 12	R32  4x27 6	S5  Ø18 12	Z10  300 3

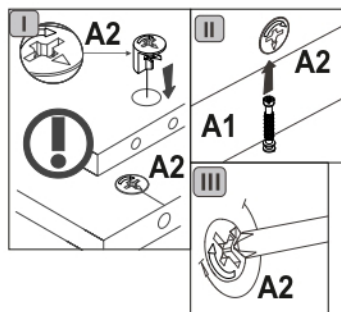
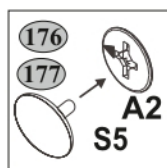
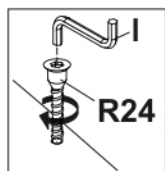
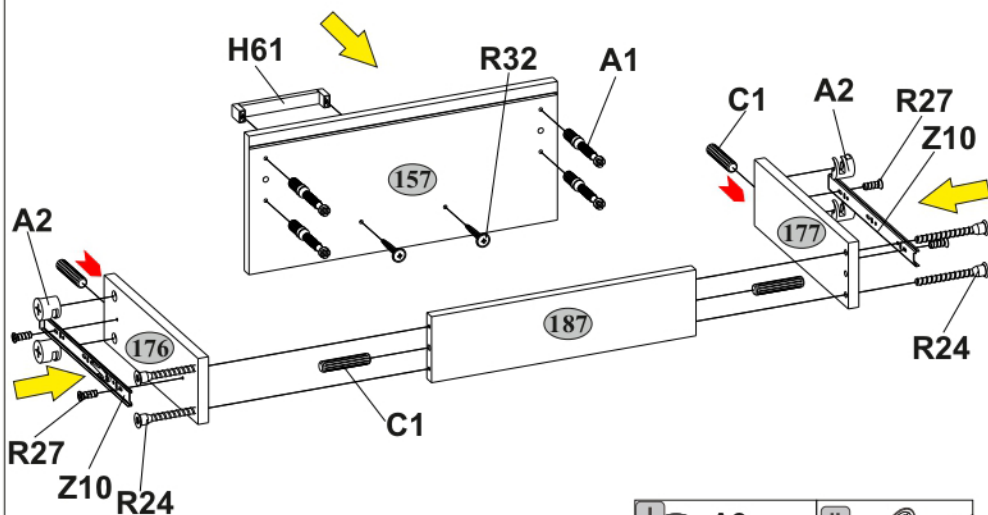
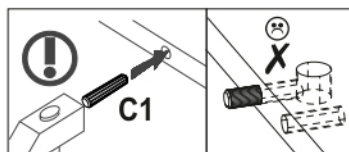
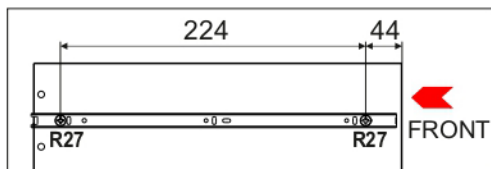

21 x3

22 x3

R3

3x20 24

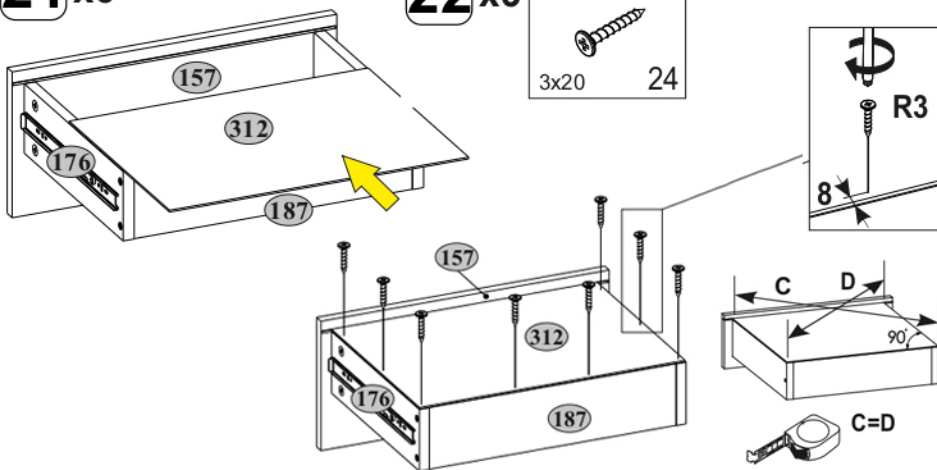

23

B5

10x50

R102

2 3,5x16

U

4 130x35x15 2

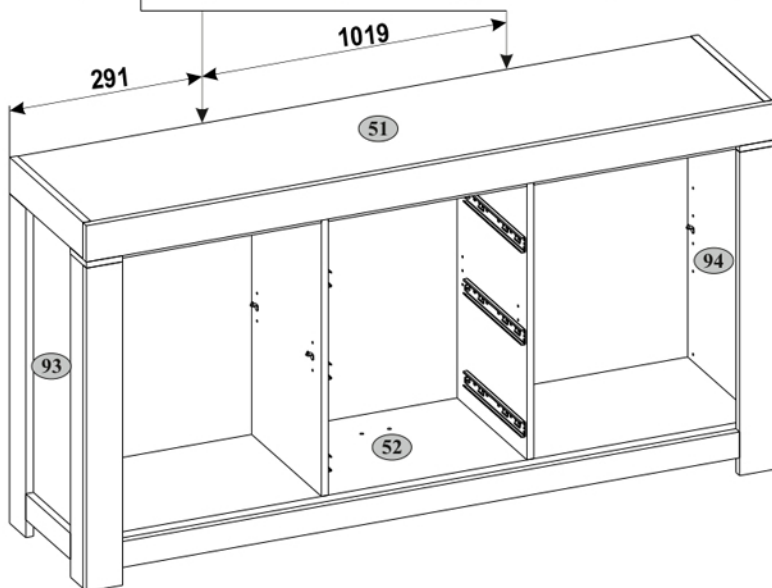
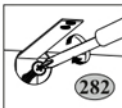
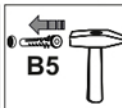
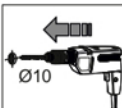
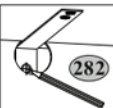
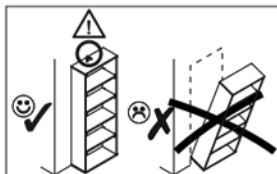

24**S5**

Ø18

4

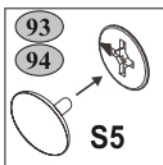
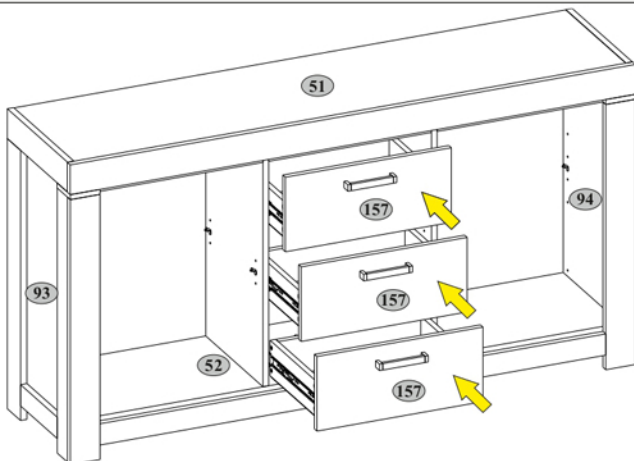
**S5****25****E16**

4

H61

2

R32

4 4x27

R102

4 3,5x16

8

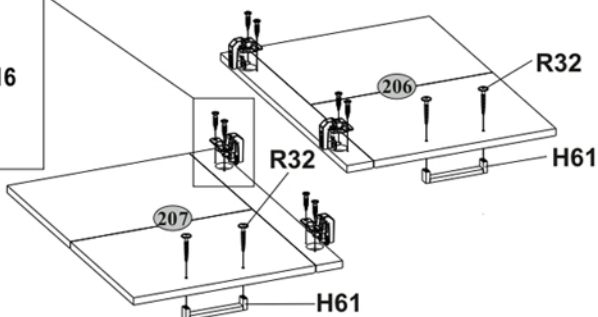
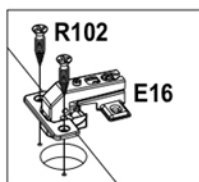
**26****R23**

6,3x13

8

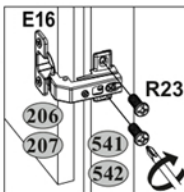
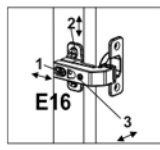
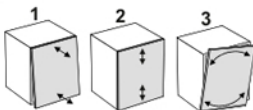

(71) (157)	max. 5 kg
------------	-----------

(52)	max. 10 kg
------	------------

(51)	max. 15 kg
------	------------

